

HARRIER

48

CODE

219L . 220L
(AUTO DRIVE) (AUTO DRIVE
ELECTRIC START)

OWNER'S HANDBOOK

CERTIFICATE OF CONFORMITY

I, the undersigned A. D. BONE, of ;
HAYTER LIMITED, Spellbrook, Bishop's Stortford,
Herts, CM23 4BU,
ENGLAND.

certify that the lawnmowers;

	CODE 219L	CODE 220L
1. Model No.	219L	220L
2. Category.	Combustion Engine	Combustion Engine
3. Make.	Hayter	Hayter
4. Type.	Rotary	Rotary
5. Engine	Briggs & Stratton	Briggs & Stratton
- Manufacturer.	127882-1570-21	127887-1571-21
- Type.	2900 rpm	2900 rpm
- Speed of rotation during test.		

Conforms to the specifications of Directive 84/538/EEC as adapted to technical progress by Directive 87/252/EEC and amended by Directive 88/180/EEC.

Guaranteed maximum sound power level.	96 dB(A)	96 dB(A)
- Type of cutting device.	Cutterbar	Cutterbar
- Width of cutting device.	48cm	48cm
- Speed of rotation of the cutting device.	2900rpm	2900rpm

TESTED AT SUDBURY,
SUFFOLK, ENGLAND.

Date: 02/09/94 02/09/94

Signed:



A.D. Bone
(Technical Manager).

EC DECLARATION OF CONFORMITY

Company Name HAYTER LIMITED.
Company Address Spellbrook
Bishop's Stortford
Herts. CM23 4BU
ENGLAND.



Machine Type No. Code 219L Harrier 48 Auto Drive
Models Code 220L Harrier 48 Auto Drive Electric Start

Directives complied with:
89/392/EEC amended by 91/368/EEC, 93/44/EEC and 93/68/EEC.
Essential Health & Safety Requirements Relating to the Design & Construction of Machinery and Safety Components.
84/538/EEC amended by 87/252/EEC and 88/180/EEC Permissible Sound Power Levels of Lawn Mowers.
89/336/EEC amended by 92/31/EEC Electromagnetic Compatibility.

Standards Used: BS5107, ISO5395, EN292, EN50081 and EN50082.

I declare on behalf of Hayter Limited that these machines conform to the EC Essential Health & Safety Requirements.

Signed:



Date: 05/01/96

A.D. Bone
(Technical Manager).

Lawnmower vibration information. RMS acceleration measured in 3 - axes at operators contact position on the handlebars. Code 219L = 8.8 ms⁻² Code 220L = 6.8 ms⁻²

CONTENTS**Page No.**

INTRODUCTION.	1.2
WARRANTY.	1.3
SAFETY PRECAUTIONS.	1.4 - 1.7
SPECIFICATIONS.	1.8
ASSEMBLY INSTRUCTIONS.	1.9
General assembly.	1.9
Assembling the mower for the first time.	1.10 - 1.11
STARTING THE ENGINE.	1.12
Before starting the engine.	1.12
To start the engine.	1.13 - 1.14
STOPPING THE ENGINE.	1.14
OPERATING THE MOWER.	1.15
Height of Cut.	1.15
Travel.	1.16
Turning the mower.	1.16
Mowing with grass collection.	1.17
Mowing without grass collection.	1.18
Heavy growth.	1.18
Transporting the mower.	1.18
Cutterbar operation.	1.19
Mowing and grass care tips.	1.19 - 1.20
MAINTENANCE.	1.21
Engine.	1.21
Grassbag.	1.21
Deck housing.	1.21
Securing nuts and bolts.	1.22
Lubrication.	1.22
Clutch cable adjustment.	1.22
Cutterbar.	1.23 - 1.24
Battery charging.	1.25
PREPARING THE MOWER FOR STORAGE.	1.26
FAULT FINDING.	1.27- 1.28
219L & 220L PARTS LIST.	2.1 - 2.3
219L & 220L MAINFRAME DIAGRAM.	2.4
219L & 220L UPPER MAINFRAME DIAGRAM.	2.5

INTRODUCTION

Thank you for purchasing a **HAYTER LIMITED** mower. The following pages are designed to help you gain safe and efficient service from your machine.

IMPORTANT :Read and understand this handbook prior to operating your machine for the first time. Make sure you are familiar with all the controls and points of regular maintenance. If you have any doubts, consult your **Hayter** authorised dealer who will be pleased to give you assistance.

All **Hayter** mowers are robustly constructed and designed for efficient economical performance under normal mowing conditions. Correct operation and maintenance will ensure a long and satisfactory service life. Prior to despatch from our factory every effort is made to ensure your machine arrives in perfect condition. Your dealer will carry out a pre-delivery inspection to ensure that there has been no transit damage prior to installation. **Please allow your dealer to familiarise you with the controls and safety features of the machine during installation.**

Throughout this handbook all references to left hand and right hand are as viewed from behind the handlebar, facing in the direction of forward travel.

This handbook is based on information available at the time of publication.

HAYTER LIMITED. reserve the right to make changes at any time without notice.

LIMITED WARRANTY

Hayter Limited warrants to the original user/purchaser that this unit shall be free from defects in material and workmanship under normal use and service for a period of two years from the date of purchase. To qualify for the full benefit of the warranty, the warranty registration card must be returned within 60 days of purchase. This warranty does not cover engines or wearing parts i.e. cutterbars, wheels and tyres. If you have any doubt, consult a **Hayter** authorised dealer for clarification. Subject to the conditions and exclusions noted in this limited warranty, we shall at our option, repair or replace any warranted part during the applicable period. Engine manufacturers furnish their own warranties and provide services through their authorised network. If you experience any difficulty, please contact a **Hayter** authorised dealer.

To qualify for the second twelve month period of the above two year limited warranty, the machine must be serviced by a **Hayter** authorised dealer. This chargeable service should be carried out within 14 months of purchase and be in accordance with the recommendations for service determined by **Hayter**. Electric start batteries are not eligible for the additional twelve months warranty cover.

This warranty does not apply to any unit that has been tampered with, altered, misused, abused or used for hire and will become invalid if non genuine **Hayter** parts are fitted. This warranty does not cover minor mechanical adjustments unless they are due to defective materials or workmanship. Consult the owners handbook or a **Hayter** authorised dealer for assistance when making these adjustments.

A warranty period of 90 days applies to machines used for commercial purposes.

To make a warranty claim, return the unit to a **Hayter** authorised dealer along with proof of purchase indicating the machine serial number and purchase date. Subject to the conditions and exclusions in this limited warranty, the authorised dealer will, at our option, repair or replace any warranted part within the duration of the warranty period.

This limited warranty gives you specific legal rights and is in addition to any statutory rights to which you may be entitled and your statutory rights are not affected by this warranty. If you need additional information concerning this written warranty, or assistance in obtaining services, please write to: **HAYTER LIMITED, Service Department, Spellbrook, Bishop's Stortford, Herts. CM23 4BU.**

Details of your local **Hayter** authorised dealer are contained in Yellow Pages or contact :-
Freephone 0800 616298.

SAFETY PRECAUTIONS

THIS SYMBOL MEANS BE ALERT! YOUR SAFETY IS INVOLVED. EXERCISE GREAT CARE AND FOLLOW THE ADVICE GIVEN TO AVOID POTENTIALLY HAZARDOUS SITUATIONS.

The Harrier 48 is perfectly safe if used correctly. Failure to observe the following simple precautions may result in serious injury.

Training:

Read the instructions carefully. Ensure that you are familiar with the controls and the proper use of the equipment. Learn how to stop the mower quickly in an emergency.



Never allow children or people unfamiliar with these instructions to use the mower.



Never mow while people, especially children, or pets are nearby.



Keep in mind that the user is responsible for accidents or hazards occurring to other people or their property.

Preparation:

While mowing, always wear substantial footwear and long trousers. Do not operate the equipment when barefoot or wearing sandals.



Thoroughly inspect the area where the mower is to be used and remove all objects which may be thrown by the machine.



WARNING: Petrol is highly flammable.

-Store fuel in containers specifically designed for this purpose.

-Refuel outdoors only and do not smoke while refuelling.

-Add fuel before starting the engine. Never remove the cap from the fuel tank or add petrol while the engine is running or when the engine is hot.

-If petrol is spilled, do not attempt to start the engine but move the mower away from the area of spillage. Avoid creating any source of ignition until petrol vapours have dissipated.



-Replace fuel tank and container cap securely.















Replace faulty silencers.

SAFETY PRECAUTIONS

Continued.

-  Always ensure that the mower is in a safe operating condition. Frequently check all nuts, bolts and screws for tightness. Use only genuine **Hayter** replacement parts.
-  Damaged cutterbars and loose fixing bolts are major hazards. Before use, visually inspect the cutting mechanism to ensure that it is in good condition. A damaged cutterbar must be replaced immediately with a genuine **Hayter** replacement part. Cutterbars which are slightly worn can be resharpened. Ensure that both cutting edges are resharpened equally to maintain balance. An unbalanced cutterbar may cause serious damage to your machine.
Refer to "Maintenance."







Operation:

-  Do not operate the engine in a confined space where dangerous carbon monoxide fumes can collect.
-  Mow only in daylight or good artificial light.
-  Avoid using the mower on wet grass, where feasible.
-  Always be sure of your footing on slopes.
-  Walk, never run.
-  Mow across the face of slopes, never up and down.
-  Exercise extreme caution when changing direction on slopes.
-  Do not mow excessively steep slopes.
-  Use extreme caution when reversing or pulling the mower towards you.
-  Stop the engine if the mower has to be tilted for transportation when crossing surfaces other than grass and when transporting the mower to and from the area to be mowed.
-  Never operate the mower unless the guards are securely in position and in good condition.
-  Do not change the engine governor settings or overspeed the engine.
-  Disengage the rear roller drive clutch before starting the engine.

SAFETY PRECAUTIONS

Continued.

Operation continued:

-  Start the engine carefully, with feet well away from the cutterbar.
-  Do not tilt the mower when starting the engine.
-  Do not put hands or feet near or under rotating parts.
-  Never pick up or carry a mower while the engine is running.
-  Stop the engine and disconnect the spark plug lead:
 - Before clearing blockages or unclogging the discharge chute.
 - Before cleaning/checking or working on the mower.
-  Stop the engine:
 - Whenever you leave the mower.
 - Before refuelling.
 - After striking a foreign object. Inspect the mower for damage and make repairs before restarting and operating the mower.
 - If the mower starts to vibrate abnormally (check immediately).
-  When using the machine without the grassbag, do not lift the deflector plate whilst the mower is in operation.









WARNING: THE CUTTERBAR CAN CONTINUE TO ROTATE AFTER THE ENGINE IS SWITCHED OFF.

SAFETY PRECAUTIONS

Continued.

Maintenance and storage:

-  Keep all nuts, bolts and screws tight to ensure that the equipment is in safe operating condition.
-  Never store the mower with petrol in the tank within an enclosed area where fumes may reach an open flame or spark.
-  Allow the engine to cool before storing in any enclosure.
-  To reduce the fire hazard, keep the engine, silencer, battery compartment and petrol storage area free of grass, leaves, or excessive grease.
-  Check the grassbag frequently for wear or deterioration.
-  Replace worn or damaged parts for safety.
-  If the fuel tank has to be drained, it is essential that this be done outdoors.

DECALS

WARNING DECAL: Part No. 219189

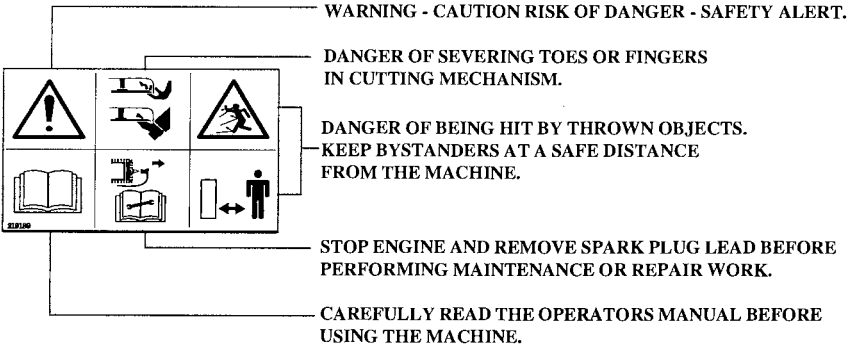

ENGINE STOP DECAL : Part No. 331046

CUT HEIGHT ADJUSTMENT DECAL :
Part No. 320006

ENGINE SPEED DECAL :



SPECIFICATIONS

MODELS	CODE 219L Auto Drive	CODE 220L Auto Drive / Electric Start
Engine Model	127882-1570-21	127887-1571-21
Engine type	Briggs & Stratton Quantum XTL 40	
Engine / cutterbar speed	2900 rpm	2900 rpm
Fuel type	Unleaded petrol	
Fuel capacity	1.5 litres (2.6 UK pints)	
Oil type	SAE 30 engine oil	
Oil sump capacity	0.6 litres (1.1 UK pints)	
Cutting width	483mm (19 inch)	
Cutting height	13 - 57mm (0.5 - 2.25 inch)	
Overall dimensions	1,359 x 521 x 1,029mm (53.5 x 20.5 x 40.5 inch)	
Dry Weight	42.4 Kg (93.5 lbs)	46.5 Kg (102.3 lbs)

ASSEMBLY INSTRUCTIONS

SAFETY NOTICE



Before using the mower, read the owners handbook carefully. Pay particular attention to the safety precautions.

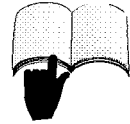

GENERAL ASSEMBLY

1. Spark Plug Lead
2. Primer Bulb
3. Fuel Cap
4. Oil Filler Cap & Dipstick
5. Battery (220L Only)
6. Handlebar Securing Knob
7. Engine Start -Grip
8. Engine Stop Lever
9. Handlebar
10. Ground Drive Clutch Lever
11. Ignition Key (220L Only)
12. Throttle Control
13. Grassbag Assembly
14. Rear Deflector
15. Height of Cut Adjuster
16. Serial Number Decal

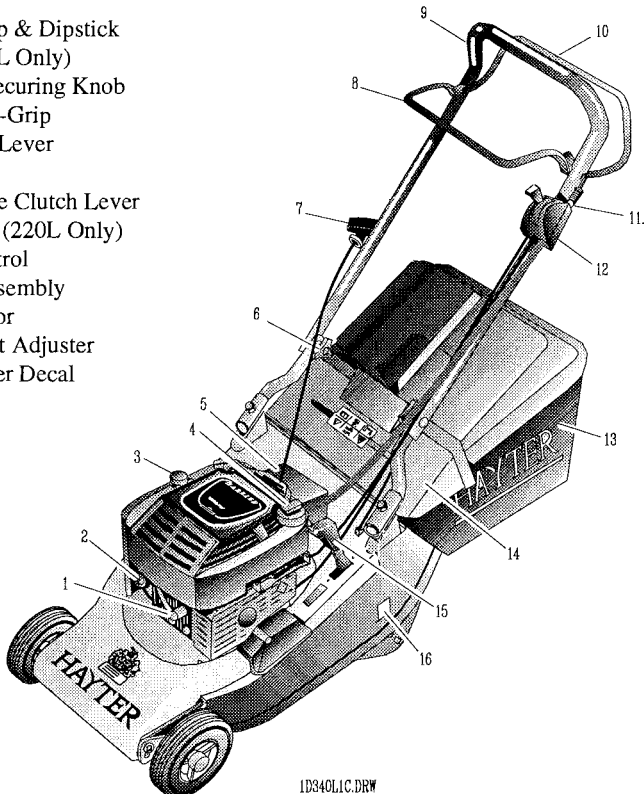

1D340LIC.DRW

ASSEMBLING THE MOWER FOR THE FIRST TIME

Check that parts are delivered correctly: Having removed the mower from the packaging, check that all loose items have been supplied correctly. Refer to the delivery checklist opposite and the general assembly. If any items are missing, contact your local Hayter Dealer.

DELIVERY CHECKLIST

Description	Quantity
Grassbag	1
Owner's Handbook	1
Engine Handbook	1
Charger (220L)	1
Ignition Key (220L)	1

Assemble the handlebar: Unscrew the knobs securing the handlebar sufficiently to allow it to be pivoted. Move the engine stop lever away from the engine to avoid damage and unfold the handlebar to its operating position. Tighten the two knobs to secure the handlebar.

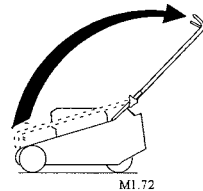

CAUTION - PREVENT DAMAGE : When unfolding the handlebar, take care to ensure that the controls and cables do not become damaged. Always replace damaged controls and cables before using the mower.

Assemble the grassbag: Identify the grassbag and remove the long ribbon label (when fitted) by cutting it off close to the grassbag. Discard the ribbon label.



WARNING - AVOID ENTANGLEMENT : Completely remove this ribbon before using the mower

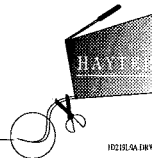

Raise the rear deflector and connect the grassbag to the upper mounting points. Lower the grassbag to rest against the rear of the mower. Finally lower the rear deflector to rest against the top of the grassbag.

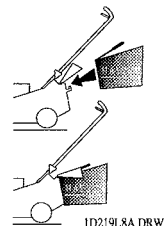

ASSEMBLING THE MOWER FOR THE FIRST TIME

Continued.

Check that all fasteners are secure.

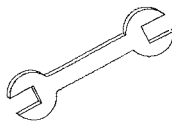

Check engine stop lever operation: Operate the engine stop lever several times. Ensure that the cable moves freely and that the lever returns automatically to the engine stop position when released.

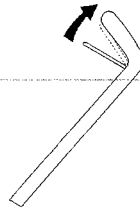

Check throttle lever operation: Operate the throttle lever several times and ensure that the cable moves freely whilst operating the engine throttle mechanism.

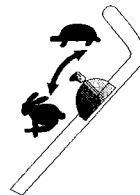

Check clutch lever operation: Operate the clutch lever several times and ensure that the cable moves freely.



Charge the battery: (Electric start model only).
Refer to "Maintenance".



PREVENT ENGINE DAMAGE: The engine is shipped without oil or petrol. The engine must be filled with the correct grade of oil and petrol before starting the engine - refer to "Before starting the engine".

STARTING THE ENGINE

BEFORE STARTING THE ENGINE

Read the engine operating and maintenance instructions handbook supplied with this mower.

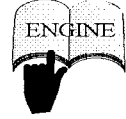

WARNING: The cutterbar rotates when the engine is operating.

ALWAYS operate the engine stop lever several times and ensure the engine stop cable moves freely before starting the engine.

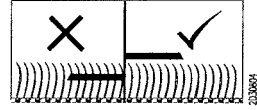

ALWAYS position the mower on a level stone free grass surface before starting the engine. Ensure that the cutterbar is set above grass height to prevent the engine being started under load.

Check oil level: With the mower on a level surface, unscrew and remove the oil filler - dipstick. Wipe oil from it with a clean cloth. Screw the oil filler - dipstick back in place, then unscrew and remove it to check the oil level.

The oil level is correct when it is between the **add** and **full** marks on the dipstick.

Add SAE 30 engine oil as necessary and replace the oil filler dipstick.

IMPORTANT: The oil filler - dipstick must be secured when the engine is running.

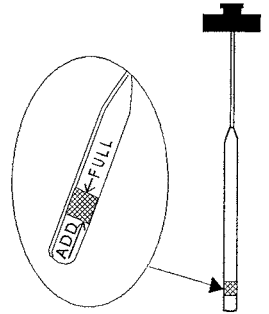

Check fuel level: Remove the fuel filler cap and fill the fuel tank with clean unleaded petrol.

Do not overfill the fuel tank. Allow 6mm minimum of tank space for fuel expansion.

IMPORTANT: The fuel filler cap must be secured when the engine is running.

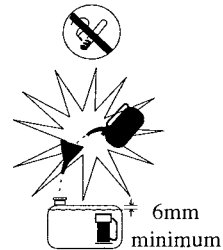

TO START THE ENGINE

Operate the throttle control lever: Push the lever to the fast position.



Operate the primer bulb: Push on the primer bulb 3 times at 2 second intervals to provide the extra fuel required to start a cold engine. Operation of the primer bulb is usually unnecessary when starting a warm engine.

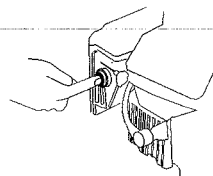

Operate the engine stop lever: Use one hand to hold the engine stop lever in the operating position firmly against the handlebar. To start and operate the engine the engine stop lever must be held in the operating position. If the engine stop lever is released the engine will stop.

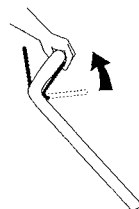

Operate the engine start - grip: (Pull start models):Stand behind the mower and maintain a firm hold on the handlebar and the engine stop lever to prevent the mower moving towards you. Use your right hand to hold the engine start-grip and pull rapidly to crank the engine. When the engine starts carefully return the engine start - grip to the storage position. If the engine does not start after 5 attempts - refer to "Fault Finding".

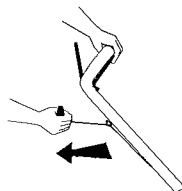

IMPORTANT: Prevent engine damage. Never pull the engine start-grip when the engine is running.

TO START THE ENGINE

Continued.

Operate the key switch: (Electric start models only). Stand behind the mower and maintain a firm hold on the handlebar and the engine stop lever to prevent the mower moving towards you. Using your left hand turn the ignition key clockwise and hold in position to crank the engine. When the engine starts release the key.

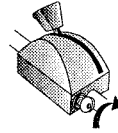

NOTE: Engine starter motor life is prolonged by using short start cycles of several seconds. Cranking the engine for more than 15 seconds every minute can damage the starter motor.

If the engine does not start - refer to "Fault finding".

NOTE: If necessary the engine can be started manually without using the key switch - refer to "Operate the engine start - grip".

IMPORTANT: Prevent engine damage - Do not operate the ignition key when the engine is running.

STOPPING THE ENGINE

Stopping the engine: Disengage the engine stop lever by releasing the lever.

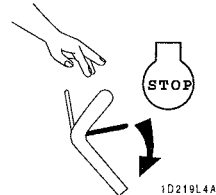

1D219L4A

Emergency stop: If the engine stop lever fails, disconnect the spark plug lead to stop the engine.

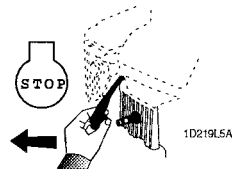

1D219L5A

SAFETY NOTICE

- !** **WARNING: PREVENT ACCIDENTAL STARTING -**
Always stop the engine and disconnect the spark plug lead before cleaning, inspecting or working on the machine.

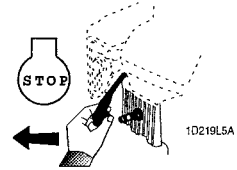

SAFETY NOTICE

- !** **CAUTION: Before mowing, thoroughly inspect the area where the mower is to be used and remove all stones, sticks, wires, bones and other foreign objects, which when contacted by the mower cutterbar could become dangerous projectiles.**
Inspect the area for hidden obstructions which when contacted by the cutterbar could risk health and safety. Remember the location of these obstructions and ensure that you mow around them.



- !** **CAUTION: Prevent engine damage - DO NOT use the mower on a slope greater than 20 degrees.**

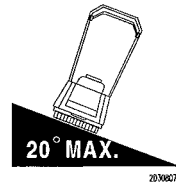

HEIGHT OF CUT

To adjust the height of cut : Grip the lever and pull sideways to disengage it from the locking notch, then push forwards to lower or pull backwards to raise the height of cut. Finally release the lever at the required position and ensure it locks firmly into one of the nine setting notches.

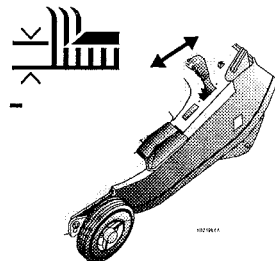

Always select a height of cut to suit operating conditions. Aim to prevent engine overloading and blockages by avoiding low cuts in long grass conditions. Be prepared to make two cuts when the grass is long.

TRAVEL

Forward travel : Hold the handlebar and operate the clutch lever to achieve forward travel.



Travel speed is controlled by engine speed. Increase engine speed to increase forward travel speed.

Release the clutch lever to stop forward travel.

When the clutch lever is disengaged the mower can be operated as a push model. This feature is useful when mowing confined areas.

Reverse travel : Disengage the clutch lever. Hold and pull against the handlebar with both hands to reverse the mower towards you.



! WARNING: PREVENT ACCIDENTS - Always reverse the mower carefully towards you. Always switch off the engine before walking backwards with the mower.

The travel speed can be reduced, if desired, by using an optional 'Kit Speed Reduction' - Part No. 219207 which is available through your Hayter dealer.

TURNING THE MOWER

To make a wide turn : Steer the mower with the handlebar whilst travelling forward.

To make a tight turn : Stop forward travel. Apply downward pressure on the handlebar to raise the front wheels of the mower just above ground level and steer the mower using the handlebar in the required direction.

! WARNING: PREVENT ACCIDENTS - DO NOT raise the front of the mower excessively when making a turn. NEVER raise the rear of the mower when the engine is running.

MOWING WITH GRASS COLLECTION

The grassbag is designed to collect grass clippings.

To achieve best grass collection performance, mow at maximum engine speed in dry operating conditions.

Recognise that when the grassbag is full the airflow stops and the grassbag deflates.

! WARNING: PREVENT ACCIDENTS - ALWAYS check the condition of the grassbag for signs of damage. Replace a damaged grassbag immediately. DO NOT operate the mower with a damaged grassbag. ALWAYS stop the engine and disconnect the spark plug lead before attempting to remove a grass blockage.

Grassbag attachment: Raise the rear deflector and connect the grassbag to the mounting points. Rest the grassbag against the rear of the mower and finally lower the rear deflector to rest against the top of the grassbag.

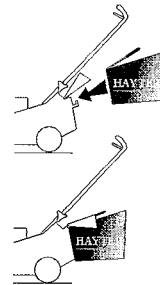

Grassbag removal: Raise the rear deflector and lift the grassbag away from the mower. Finally lower the rear deflector to rest against the rear of the mower.

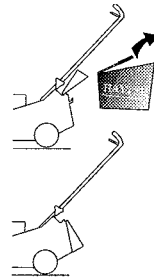

Grassbag emptying: To empty the grassbag, pour out the grass clippings and shake the grassbag vigorously to clean the airways. Good grass collection depends on good air flow through the grassbag. When collecting grass clippings it is important that the grassbag is emptied regularly to prevent blockages and engine overloading.

MOWING WITHOUT GRASS COLLECTION

To mow without collecting the grass clippings, remove the grassbag and operate the mower with the rear deflector in its lowest position.

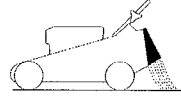

WARNING: PREVENT ACCIDENTS - ALWAYS check the condition of the rear deflector for signs of damage. Replace a damaged rear deflector immediately. Never operate the mower with a damaged rear deflector.

HEAVY GROWTH

Areas of heavy growth should be mown without grass collection. If grass collection is required first mow the area without grass collection at the maximum height of cut setting. Allow the grass clippings to dry out and then mow the area at the maximum height of cut setting with the grassbag fitted. Reduce the height of cut and mow the area again as necessary until the required finish is obtained.

TRANSPORTING THE MOWER

Set the mower to its maximum height of cut to protect the cutting mechanism when transporting the mower over surfaces other than grass.



WARNING: PREVENT ACCIDENTS - Transport the mower carefully at slow walking speed with the engine switched off.

CUTTERBAR OPERATION

The cutterbar rotates at the same speed as the engine. The cutterbar will stop within five seconds of the engine being switched off.

! **WARNING: PREVENT ACCIDENTS - DO NOT operate the mower if the cutterbar fails to stop within five seconds. Return the mower to your Hayter dealer for examination and repair.**

The cutterbar is driven by the engine via a friction device to help prevent damage occurring to the cutting mechanism when a hidden obstruction or overload is encountered. When the obstruction or overload situation is removed the friction device will automatically reset.

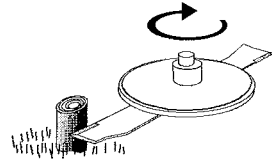

! **WARNING: PREVENT ACCIDENTS - ALWAYS stop the engine when a hidden obstruction or excessive vibration is encountered. Disconnect the spark plug lead and examine the cutting mechanism. ALWAYS replace a damaged cutterbar - refer to "Maintenance".**

MOWING AND GRASS CARE TIPS

In dry weather conditions leave the grass long to help retain ground moisture.

Aerate the lawn to stimulate soil organisms and root growth. In spring and late summer remove dead grass and aerate the lawn by raking or using a purpose made product.

Maintain a sharp cutterbar. A blunt cutterbar will tear the grass and cause the tips to turn brown.

MOWING AND GRASS CARE TIPS

Continued.

Prevent scalping. Plan your direction of travel to mow across hollows and humps.

Prevent grass damage. Stop forward travel when making a turn.

Prevent grass damage. DO NOT mow in wet conditions.

Brush the lawn surface to disperse worm casts before mowing.

Spike compacted lawn areas with a fork. Fill the holes with sand to improve aeration and drainage.

Mow lawns in a different direction to the previous cut.

As a general rule the grass clippings should be removed each time you mow. If weather conditions are dry and hot and the grass is weed free, leave the clippings on the lawn to help maintain ground moisture.

Mow lawns twice a week when the grass is growing vigorously in the summer.

Mow lawns once a week in spring, autumn and during prolonged dry weather in the summer.

Prevent grass damage - DO NOT remove more than one third of the grass height in one cut.

Recommended grass heights for lawns:

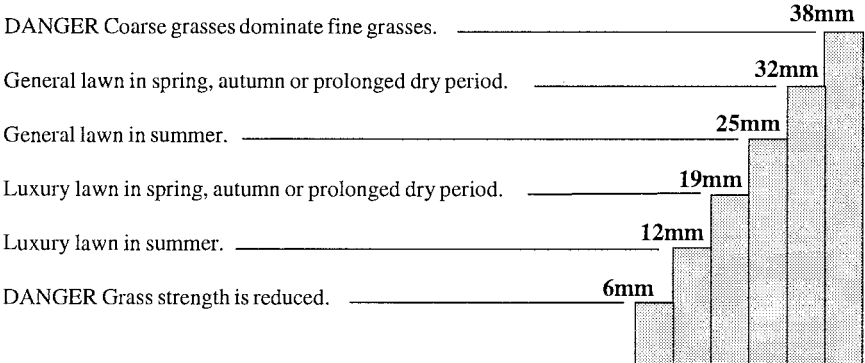

MAINTENANCE

ENGINE

Engine handbook: For details of engine maintenance refer to the engine operating and maintenance instructions handbook supplied with your mower.

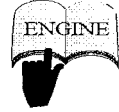

IMPORTANT - Draining engine oil: To drain the engine oil, first drain fuel by operating the engine until the fuel tank is empty and the engine stops. Remove the spark plug lead and allow the engine to cool. Position the mower on its left hand side and ensure that the air cleaner side of the engine is kept uppermost to prevent engine damage. Remove the oil filler-dipstick to drain the oil.

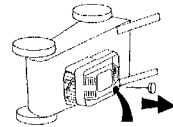

CAUTION: PREVENT INJURY - It is wise to seek assistance when turning the mower on its side.

GRASSBAG

Remove grass debris from the grassbag immediately after use and check its condition for signs of damage.

WARNING: PREVENT ACCIDENTS - ALWAYS replace a damaged grassbag immediately.



DECK HOUSING

Remove grass debris from the deck housing and around the engine immediately after use.

SECURING NUTS AND BOLTS

Regularly check that all securing nuts and bolts are tight.
Replace missing or damaged items immediately.

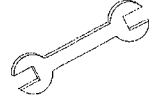
**LUBRICATION**

Lubricate the wheels, pivot points and linkages with engine oil every 25 operating hours.

Apply a good quality medium grease to the inner control cables at the point of entry and exit from their outer casings.

**CLUTCH CABLE ADJUSTMENT**

Check the clutch cable operation every 25 operating hours and adjust if necessary. The clutch cable is adjusted correctly when the belt drive just engages with the clutch lever positioned - 32-38mm (1.1/4"-1.1/2") from the handlebar.

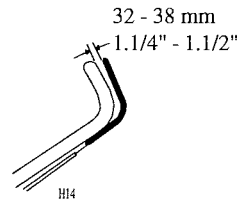

Unscrew the lock nut and screw the adjuster as necessary.
Tighten the locknut when correctly adjusted.

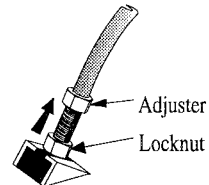

**IMPORTANT: Prevent damage - ALWAYS operate the mower with the clutch cable correctly adjusted.
ALWAYS replace damaged cables.**

CUTTERBAR

! **WARNING: PREVENT ACCIDENTS** -Never work on the cutterbar unless the spark plug lead has been removed. The cutterbar has sharp edges. **ALWAYS** wear strong gloves to protect your hands when working on the cutterbar. **DO NOT** operate tools towards the cutting edges to avoid the risk of injury should the tool slip. **ALWAYS** use genuine Hayter replacement parts.

The condition of the cutterbar and its mounting arrangement should be checked regularly for signs of wear or damage. Ensure that the cutterbar is not bent or cracked.

A damaged cutterbar that is out of balance will vibrate excessively and may break. **DO NOT** use an unbalanced cutterbar.

Regularly check that the bolt securing the cutterbar is tightened to the specified torque of 54Nm (40 lbs. ft.).

Replace the cutterbar every 2 years or sooner if excessively worn or damaged.

How to remove the cutterbar: Drain the fuel by operating the engine until the fuel tank is empty and the engine stops. **Remove the spark plug lead** and allow the engine to cool. Turn the mower on its left hand side and ensure that the air cleaner side of the engine is uppermost.

! **CAUTION: PREVENT INJURY** - It is wise to seek assistance when turning the mower on its side.

Firmly grip the end of the cutterbar with the gloved hand and remove the bolt, spring washer and distance piece securing the cutterbar.

How to assemble the cutterbar: Assemble the cutterbar with the turned up edges facing towards the engine. Secure the cutterbar using the original bolt, spring washer and distance piece and tighten to a torque of 54Nm (40 lbs.ft.).

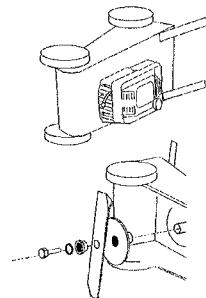

CUTTERBAR

Continued.

How to sharpen and balance the cutterbar: A slightly worn cutterbar may be re-sharpened. All cutting edges must be sharpened equally to ensure balance. Sharpen the cutterbar every 25 mowing hours or more frequently if conditions require. Remove the cutterbar from the mower and clean using a brush and water. Inspect the cutterbar for signs of damage.

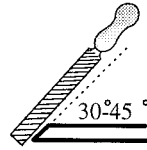

! **DO NOT** use a damaged or excessively worn cutterbar.

Sharpen all the cutting edges with a flat file to restore the original cutting edge.

Ensure that the cutterbar is balanced. Use a screw driver with a round shaft to support the cutterbar through its centre hole. Hold the cutterbar horizontal and then release. A balanced cutterbar will remain horizontal. If the cutterbar is not balanced the heavy end will rotate downwards. Sharpen the heavy end until the cutterbar is correctly balanced.

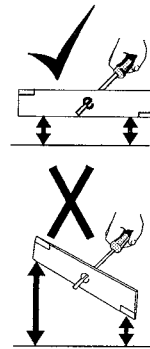

BATTERY CHARGING

(Electric Start Models Only)

! **WARNING: PREVENT ACCIDENTS - ALWAYS charge the battery in a well ventilated area.**

NEVER charge the battery near naked flames or direct heat.

ALWAYS switch off the mains electricity supply before disconnecting the charger from the battery.

ALWAYS use the battery charger supplied with the mower.

Battery charging should not be necessary during normal use. The engine operation will automatically charge the battery. If the mower is stored for a long period recharging the battery may be necessary to permit electric starting.

Charge the battery only when necessary.

To recharge the battery:

Disconnect the battery lead from the mower lead and then connect the battery lead to the charger.

Connect the charger plug to the mains electricity supply and switch on to charge the battery for a six hour period.

Switch off the mains electricity supply and disconnect the charger plug.

Disconnect the battery lead from the charger and then connect the battery lead to the mower lead.

! **IMPORTANT: NEVER connect the battery charger to the engine lead as this will cause the charger to be permanently damaged. Chargers damaged in this manner will not be replaced under warranty.**

! **CAUTION: PREVENT ENVIRONMENTAL DAMAGE - Dispose of used battery correctly. The battery has a separate collection mark. This means that the battery must not be disposed of with general waste, but must be taken to an authorised disposal site.**

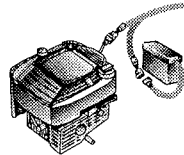
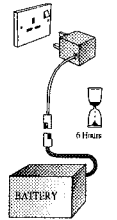

PREPARING THE MOWER FOR STORAGE

Handlebar storage: To lower the handlebar unscrew the 2 securing knobs sufficiently to allow it to be pivoted forwards to rest against the mower. Take care to ensure that the control cables do not become snagged at the pivot point and depress the engine stop lever to prevent it being damaged through contact with the engine spark plug.

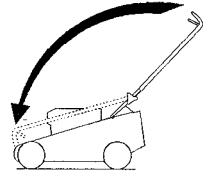

Storage for long periods: To ensure your mower is maintained in good working order it is important that the following procedure is adopted when the mower is stored for periods in excess of one month. Refer to the maintenance section and engine handbook as necessary.

Drain fuel from the engine by operating the engine until it stops.

Disconnect the spark plug lead. Change the engine oil.

Remove the engine spark plug and pour 15ml of engine oil into the engine cylinder and replace the spark plug. **Do not** exceed the stated volume of oil as engine damage may occur on re-starting. Operate the engine brake lever and slowly pull the engine start - grip once to crank the engine. This will distribute the oil and help prevent engine corrosion.

Clean all areas of the mower and ensure that the grassbag is clean.

Charge the battery (Electric start models only).

Lubricate the mower.

Treat metal parts with a water repellent anti-corrosion product.

Lower the handlebar, if desired.

Rest the mower deck on wooden blocks to remove the weight of the mower from its wheels / roller.

Cover the mower with a protective sheet and store it in a dry, ventilated area.

FAULT FINDING

PROBLEM	POSSIBLE FAULT	REMEDY
Engine will not start.	Fuel starvation.	Fill fuel tank.
	Incorrect / contaminated fuel.	Drain fuel tank and fill with correct fuel.
	Spark plug lead disconnected.	Connect spark plug lead.
	Throttle setting incorrect.	Set throttle to fast position.
	Engine brake not released.	Operate engine brake lever.
	Faulty spark plug.	Clean and adjust gap or replace.
Engine runs rough.	Battery discharged. (Electric start models).	Charge battery.
	Wiring fault. (Electric start models).	Check wiring.
	Spark plug lead becoming disconnected in use.	Connect spark plug lead.
Engine vibrates excessively.	Faulty spark plug.	Clean and adjust gap or replace.
	Air cleaner element blocked.	Replace air cleaner element.
	Incorrect / contaminated fuel.	Drain fuel tank and fill with correct fuel.
	Mounting bolts loose.	Tighten bolts.
	Cutterbar bolt loose.	Tighten bolt.
	Cutterbar out of balance.	Balance cutterbar.

FAULT FINDING

Continued.

PROBLEM	POSSIBLE FAULT	REMEDY
Uneven cut.	Undulating ground contours.	Change direction of travel.
	Cutterbar worn.	Sharpen the cutterbar.
	Cutterbar out of balance.	Balance cutterbar.
	Wheels / Roller damaged.	Inspect and replace as necessary.
Discharge chute blocks.	Grass is wet.	Mow dry grass.
	Cut height too low.	Increase cut height.
	Grassbag full.	Empty grassbag.
	Slow engine speed.	Increase engine speed.
	No airflow through the grassbag.	Clean the grassbag.
Mower is hard to push.	Cut height too low.	Increase cut height.
	Wheels / Roller damaged.	Inspect and lubricate or replace as necessary.
Mower will not self propel.	Clutch out of adjustment.	Adjust clutch cable.
	Drive belt damaged.	Replace drive belt.
Poor grass collection.	No airflow through the grassbag.	Clean the grassbag.
	Discharge chute blocked.	Remove blockage.
	Slow engine speed.	Increase engine speed.
	Wet grass.	Mow dry grass.
	Grassbag full.	Empty grassbag.

PARTS LIST

ITEM NO.	DESCRIPTION	PART NO.	QTY.
1	Belt	219110	1
2	5/8" Circlip	1428	1
3	Woodruff Key	1662	1
4	3/16" Washer	09257	3
5	Spring	5421	1
6	Cutterbar - 19"	4013	1
7	5/8" Plain Washer	09286	1
8	Grip Fix - 5/16"	04020	2
9	Bush	4452	1
10	M6 x 12 Countersunk Screw	09545	4
11	Wheel	5218	2
12	Hub Cap	219143	2
13	M6 Nut - Nylon Insert 'T' type	09544	1
14	Pivot Pin	340182	2
15	1/2" Plain Washer	02575	2
16	Friction Disc	219203	1
17	5/16" Plain Washer	09266	2
18	1/2" Plain Washer	09280	2
19	M6 Plain Washer	09472	4
20	Deflector Stop	5323	1
21	3/4" Circlip	02708	2
22	1/2" Circlip	03096	1
23	3/16" x 3/4" Roll Pin	03997	2
24	3/8" UNC x 1.1/4" Taptite Screw	09349	3
25	3/8" UNF x 1.1/4" Hex. Hd. Setscrew	09116	1
26	1/2" UNF Nylon Insert Nut	4486	2
27	5/16" Starloc Washer	0201086	2
28	Lever Cover - Height Adjuster	330053	1
29	3/8" Spring Washer	09273	1
30	Pulley	219111	1
31	Spring	1246	1
32	No. 8 x 1. 1/2" Pozi Pan Screw	09600	2
33	M6 x 20 Hex. Washer Hd. Taptite Screw	09575	18
34	Ratchet Plate - 9 Tooth	340102	1
35	M8 x 35 Coach Bolt	09548	4
36	M6 x 12 Washer Head Taptite Screw	09546	3
37	M8 Nut Nylon Insert 'T' Type	09441	4
38	Rivet	09320	3
39	M6 x 20 Coach Bolt	09668	2
40	M6 x 30 Hex. Head Bolt	09547	1
41	6mm x 20 Screw	09687	2

PARTS LIST

ITEM NO.	DESCRIPTION	PART NO.	QTY.
42	M8 x 45 Coach Bolt	09569	2
43	Distance Piece	216008	1
44	19mm Nylon Washer	09688	2
45	Mainframe Assembly (includes item 46)	219185V	1
46	Throwplate	219011	1
47	Idler Sprocket Sleeve Assembly	219095	1
48	Lower Handlebar	219019	1
49	Cable Clip	219097	1
50	Rear Roller Frame (includes item 102)	219181W	1
51	Transmission Cover	219055	1
52	Jockey Lever	219023	1
53	Sprocket - 10 Teeth	219106	1
54	Securing Plate	219028	1
55	Woodruff Key	5321	1
56	Connecting Rod	219030	1
57	Front Axle Assembly	219031	1
58	Bearing Moulding	219036	2
59	Securing Plate	219037	2
60	Jockey Pulley	219156	1
61	Sprocket - 17 Teeth	219051	1
62	M8 Nut Cap	234051	4
63	Lever Engine	340179	1
64	Sleeve Sprocket Tube	219053	1
65	Clutch Cable Bracket Stop	239052	1
66	Coupling	219142	1
67	Roller Assembly	219044	1
68	Bearing Housing Moulding	219060	1
69	Pulley Assembly	219140	1
70	Bracket Belt Guide	219064	1
71	Chain	219054	1
72	Transmission Cover	219067	1
73	Underguard	219069	1
74	Rear Deflector	219072	1
75	Pivot Rod	219074	1
76	Deflector Spring - R / H	219096	1
77	M6 Plain Nut	09437	3
78	'E' Clip	305092	1
79	Rope Guide	305093	1
80	Clutch Lever	306094W	1
81	Height of Cut Decal	320006	1
82	M6 Spring Washer	09474	3

PARTS LIST

ITEM NO.	DESCRIPTION	PART NO.	QTY.
83	Caution Decal	219189	1
84	Handwheel	226013	2
85	Grassbag Fabric	219081	1
86	Clutch Cable	219070	1
87	Deflector Spring - L / H	219075	1
88	Roller Bearing Housing	219102	2
89	Grassbag Cover	219082	1
90	Avdel Rivet	09318	1
91	Cable Tie	3966	2
92	Decal - Engine Stop	331046	1
93	Grassbag Handle	219083	1
94	Grassbag Frame Assembly	219077	1
95	'U' Tube	219080	1
96	Decal - Hayter & Royal Warrant	219186	1
97	Brush Seal	340082	1
98	Front Fin Insert	219182	1
99	Charger (Code 220L)	226006	1
100	Upper Handlebar	219165W	1
101	Bush	340154	2
102	Height Of Cut Lever	340013	1
103	Rope Stop	MU42189	1
104	Nylon Washer	4017	2
105	Throttle Control (Code 219L)	219161	1
	Throttle Control, Switch & cable (Code 220L)	220033	1
106	Engine - Compliance A.P.T.O. (Code 219L)	219160	1
	Engine - Compliance A.P.T.O. (Code 220L)	220032	1
107	Decal - Engine (Code 219L)	219187	1
	Decal - Engine (Code 220L)	220041	1
108	Battery 12V (Code 220L)	220015	1
109	Battery Clip (Code 220L)	220014	1
110	Avdel Rivet (Code 220L)	09318	2
111	Battery Bracket (Code 220L)	220013	1
112	Ignition Key (Code 220L)	6426	1
113	Grassbag Assembly (Includes Items 4, 38, 85, 89, 93, 94 & 95)	219076	1
114	M6 X 20 Washer Hd. Taptite Screw	09575	4

